

MODEL: SC28000-DDR

DESCRIPTION	MATERIAL & SPECIFICATION
Electrical Connection	Valve Plug DIN 43650
Connection Size	1"PF
Probe Material	SUS304
Tuning Fork Material	SUS304
Viscosity	1~10,000 cSt
Supply Voltage & Output	20~250Vac/Vdc, 50/60Hz 2 Wire Contactless Electronic Switch
Operating Temp.	-40°C~100°C
Ambient Temp.	-40~80°C
Storage Temp.	-40~85°C
Operation Pressure	Max. 40Bar
Density	Solid 0.07g/cm ³ , Liquid 0.7g/cm ³

TUNING FORK LEVEL SWITCH

Copyright, without permission, is prohibited reproduction, retained or circulated Rights Reserved.

REV.	DATE	REVISION SECTION

<p>FineTek Co., Ltd. e-mail: info@fine-tek.com http://www.fine-tek.com</p>	SA APPROVED	APPROVED BY CLIENT	MODEL: SC28000-DDR			
	SALES	RD/PR APPROVED <i>Fish. Cheng</i>	DRAWING	Nicole	DATE: 2016.11.25	UNIT: mm SCALE: 1:1.5

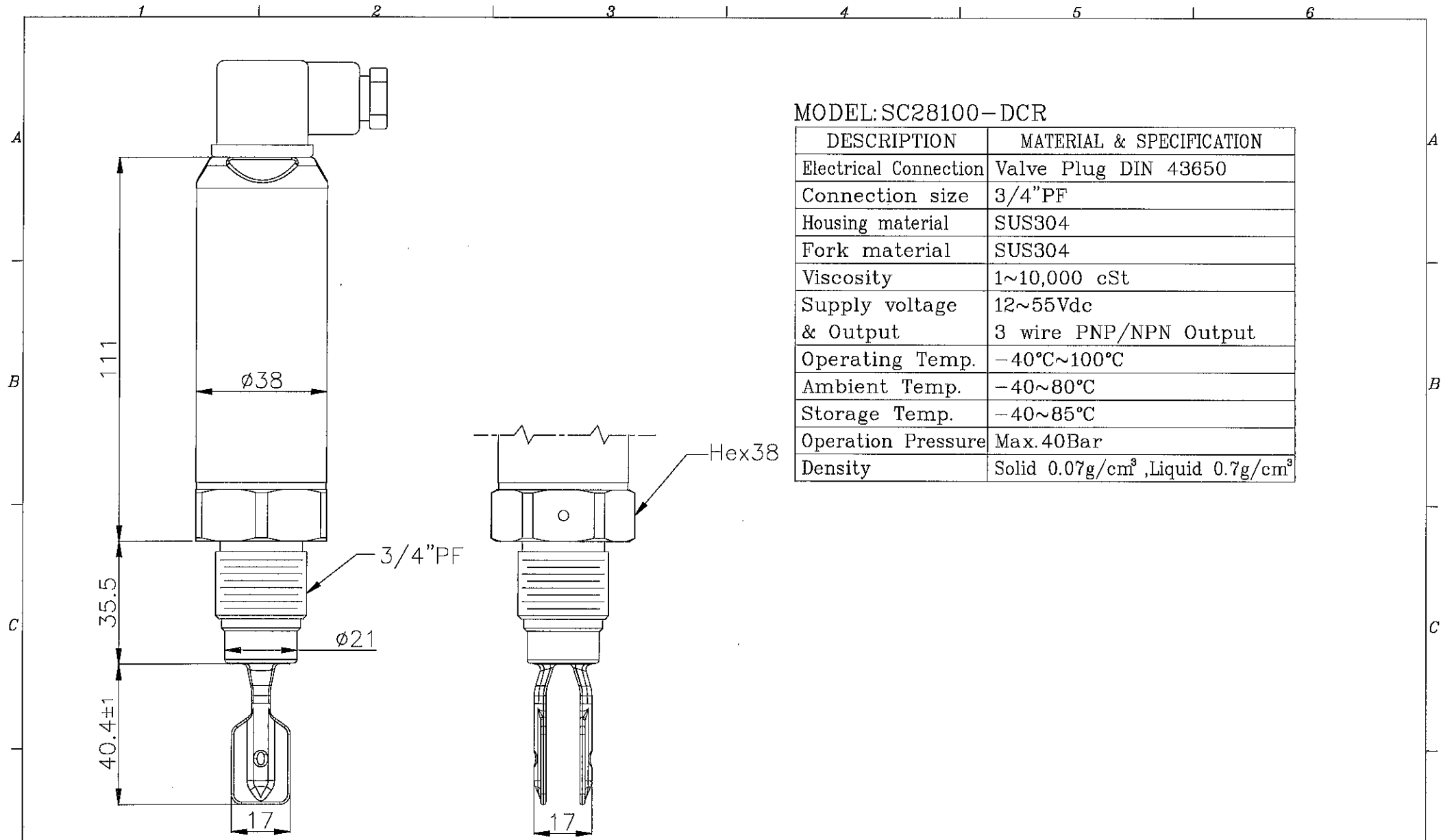

MODEL: SC28100-DCR

DESCRIPTION	MATERIAL & SPECIFICATION
Electrical Connection	Valve Plug DIN 43650
Connection size	3/4"PF
Housing material	SUS304
Fork material	SUS304
Viscosity	1~10,000 cSt
Supply voltage & Output	12~55Vdc 3 wire PNP/NPN Output
Operating Temp.	-40°C~100°C
Ambient Temp.	-40~80°C
Storage Temp.	-40~85°C
Operation Pressure	Max. 40Bar
Density	Solid 0.07g/cm ³ ,Liquid 0.7g/cm ³

TUNING FORK LEVEL SWITCH

Copyright, without permission, is prohibited reproduction, retained or circulated Rights Reserved.

FineTek Co., Ltd. e-mail: info@fine-tek.com http://www.fine-tek.com	SA APPROVED	APPROVED BY CLIENT	MODEL: SC28100-DCR		
	SALES	RD/PR APPROVED <i>Fish.Cheng</i>	DRAWING	Nicole	DATE: 2018.01.16
					UNIT: mm SCALE: 1:1.5
					REV. DO



www.fine-tek.com

Tuning Fork Level Switch



PRODUCT INTRODUCTION

WORKING PRINCIPLE

The SC series is a vibrating tuning fork point level sensor that utilizes piezoelectric crystal and solidstate electronics technology to produce vibration in the tuning fork element at a specific frequency and receive electronic feedback. When the probe element is in contact with the target material, the vibration is dampened, the electronic feedback changes, and presence of the material is thereby sensed by the electronics which changes the state of the sensor output to indicate material presence. When the probe element is again free of the target material, the vibration again is produced and the output state reverts to indicate material absence.

FEATURE

- SPDT Relay output, SSR MOSFET output.
- Wide voltage supply range 20~250 Vac/Vdc,50/60Hz
- No frequent calibration required, easy-to-use, sturdy and durable design. High/low failure safe mode, safe and reliable.
- Sensitivity adjustment is available for different densities of media. Fine powder can be detected.
- Suitable for liquid, powder, and solid application.
- Dual insulation can reduce damage on the PCB board caused by great changes in temperature and humidity, as well as condensation effects (SC3□ series).
- It can be tested by pressing the test button after installation (SC3□ series).
- Output switch delay function (SC3□ series).
- Self-diagnosis mechanism can detect the abnormality such as the abrasion of the tuning fork or the material viscosity (SC3□ series).
- The compact built-in wiring box can save the installation space (SC3□ series).
- The wiring box can rotate 270 degrees, facilitating adjustment of the inlet direction (SC3□ series).
- The minimum measurable specific gravity can reach 0.01 g/cm³ (SC35 series).
- Ultra protection mechanism can set the secondary output contact point as alarm output (SC35 series).
- Support the function of detecting underwater sediments (SC35 series).
- All-in-one design, 3/4" (SC38), 1" thread is suitable for the installation of a small tube.
- Adjustment setting for different densities of media $P > 0.5 \text{ g/cm}^3$ or $\rho.0.7 \text{ g/cm}^3$ (SC38).
- Switch delay setting function (SC3□ series).
- Alarm indicators based on failure status or output status selected according to the customer's habits (SC3□ series).
- Automatic calibration of the operation points for different densities of media as required by the customer (SC38).

APPLICABLE MATERIALS

The tuning fork level switch can be widely applied to detect the min. and max. level in tanks, silos and hoppers filled with materials of different densities and state. The following is a list of applications.

POWDER

- | | |
|------------------------|------------------------|
| 1. Powdered milk | 15. Pellets |
| 2. Frozen potato chips | 16. Peanuts |
| 3. Beans | 17. Tobacco |
| 4. Sugar | 18. Wood shavings |
| 5. Sweets | 19. Chalk |
| 6. Coffee beans | 20. Stearin chips |
| 7. Coffee powder | 21. Powdered cellulose |
| 8. Frozen dry coffee | 22. Glass fine power |
| 9. Tea | 23. Granular plastics |
| 10. Salt | 24. Gravel |
| 11. Flour | 25. Powdered clay |
| 12. Foundry sand | 26. Polystyrene powder |
| 13. Spices | 27. Styrofoam |
| 14. Animal food | 28. Soda |

LIQUID

1. Water & Solutions
2. General Purpose Solvent
3. Soy sauce
4. Heavy oil
5. Petroleum
6. Oil
7. Ink
8. Cream
9. Drink & Beverage
10. Corrosive liquid

APPLICATION SCOPE

It is applicable to the max. and min. level detection of the tanks or tubes filled with various solid/liquid media. The product has a variety of applications, such as in the chemical fiber industry, rubber industry, tire industry, cement industry, steel industry, food industry, pharmaceutical industry, and animal feed factories in terms of the level detection for the bins of the raw material/process/finished products.

APPLICATION EXAMPLE

Application situation	SC24	SC28	SC14X	SC17X	SC35X	SC38X
Liquid	★	★	★	★		★
Powder	★		★	★	★	
Solid					★	
Corrosive media			Optional			
Explosion proof				★	★	★
Tri-Clamp connection	Optional	Optional	Optional			
Operation temp. 100°C	★	★				
Operation temp. 130°C			★	★		
Operation temp. 150°C					★	★
Operation temp. 280°C					★	
Max. pressure<25Bar					★	
Max. pressure<40Bar	★	★	★	★		★
Max. pressure<60Bar						

LITE-TYPE

<p>Dimensions (Unit:mm)</p>			
<p>Model no.</p>	<p>SC24□□□ 【DIN Connector】</p>	<p>SC24□□□ 【M12 Connector】</p>	<p>SC24□□□ 【Cable Wire Type】</p>
<p>Supply voltage & output</p>	<p>SC24□□□: 20~250Vac / Vdc 2 Wire Contactless electronic switch. SC24P□□□: 12~55Vdc 3 Wire PNP output. SC24N□□□: 12~55Vdc 3 Wire NPN output.</p>		
<p>Fork length</p>	<p>100mm</p>		
<p>Ambient temp.</p>	<p>-40~85°C</p>		
<p>Ambient humidity</p>	<p>80% RH non-condensed</p>		
<p>Process temp.</p>	<p>SC24□□□T: -40~+150°C SC24□□□□: -40~+100°C</p>		
<p>Process pressure</p>	<p>Maximum 40 Bar</p>		
<p>Min. material density sensed</p>	<p>Solid:density: $\geq 0.07g/cm^3$ Liquid:density: $\geq 0.7g/cm^3$ Viscosity: 1~10000 cSt</p>		
<p>Magnetic testing</p>	<p>Output function test performed by putting magnets near the indicated spot</p>		
<p>Vibrating frequency</p>	<p>350~370Hz</p>		
<p>Status indication</p>	<p>Green light: indicate power supply Red light: indicate operating mode</p>		
<p>Housing material</p>	<p>SUS304</p>		
<p>Probe material</p>	<p>SUS304, SUS316, SUS316L</p>		
<p>IP protection</p>	<p>IP65</p>	<p>IP67</p>	<p>IP67</p>
<p>Mounting</p>	<p>1" more</p>		
<p>Conduit</p>	<p>Valve plug DIN 43650</p>	<p>M12 Connector(180° / 90°)</p>	<p>Cable connector</p>

MINI-TYPE

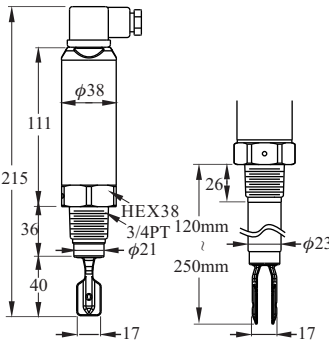
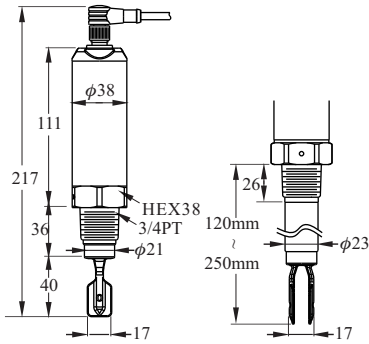
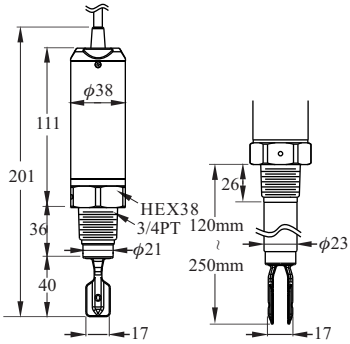
<p>Dimensions (Unit:mm)</p>	 <p>Standard Type Extension Type</p>	 <p>Standard Type Extension Type</p>	 <p>Standard Type Extension Type</p>
<p>Model no.</p>	<p>SC28□□□ [DIN Connector]</p>	<p>SC28□□□ [M12 Connector]</p>	<p>SC28□□□ [Cable Wire Type]</p>
<p>Supply voltage & output</p>	<p>SC280□□: 20~250,50/60Hz Vac/Vdc 2 Wire Contactless electronic switch. SC28P□□: 12~55Vdc 3 Wire PNP output. SC28N□□: 12~55Vdc 3 Wire NPN output.</p>		
<p>Fork length</p>	<p>40mm</p>		
<p>Ambient temp.</p>	<p>-40°C~85°C</p>		
<p>Ambient humidity</p>	<p>80% RH non-condensed</p>		
<p>Process temp.</p>	<p>SC28□□□T: -40°C~150°C SC28□□□: -40°C~100°C</p>		
<p>Process pressure</p>	<p>-1~600PSI (40BAR)</p>		
<p>Min. material density sensed</p>	<p>Liquid:density: $\geq 0.7\text{g/cm}^3$ Viscosity: 1~10000 cSt</p>		
<p>Magnetic testing</p>	<p>Output function test performed by putting magnets near the indicated spot</p>		
<p>Vibrating frequency</p>	<p>1 KHz \pm 10%</p>		
<p>Status indication</p>	<p>Green light:indicate power supply Red light:indicate operating mode</p>		
<p>Housing material</p>	<p>SUS304</p>		
<p>Probe material</p>	<p>SUS304, SUS316, SUS316L</p>		
<p>IP protection</p>	<p>IP65</p>	<p>IP67</p>	<p>IP67</p>
<p>Mounting</p>	<p>3/4"more</p>		
<p>Conduit</p>	<p>Valve plug DIN 43650</p>	<p>M12 Connector(180° / 90°)</p>	<p>Cable connector</p>

STANDARD TYPE

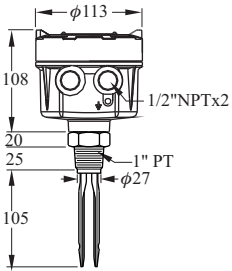
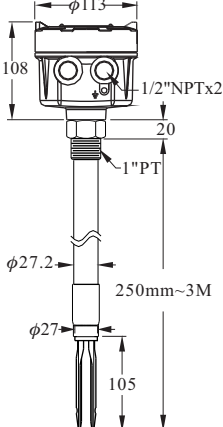
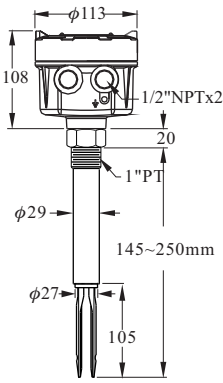
<p>Dimensions (Unit:mm)</p>			
<p>Model No.</p>	<p>SC1400 【Standard Type】</p>	<p>SC1410 【Tuning Fork Ultra Extension Type】</p>	<p>SC1420 【Tuning Fork Extension Type】</p>
<p>Level sensor housing</p>	<p>Aluminum / IP65</p>		
<p>Probe material</p>	<p>SUS 304 / 316 / 316L</p>		
<p>Mounting</p>	<p>1"PT</p>		
<p>Conduit</p>	<p>1/2"NPT × 2</p>		
<p>Max. vertical load on rod.</p>	<p>177in.Lbs(20Nm)</p>		
<p>Process pressure.</p>	<p>-1~600PSI (40BAR)</p>		
<p>Power supply</p>	<p>20~250Vac / Vdc,50 / 60Hz</p>		
<p>Power consumption</p>	<p>10VA</p>		
<p>Ambient temp.</p>	<p>-40°C~60°C</p>		
<p>Process temp.</p>	<p>-40°C~130°C</p>		
<p>Signal output</p>	<p>Relay, SPDT, 5A/250Vac / 28Vdc, 1 set or 2 set SSR(MOSFET) 400mA/60 Vac / Vdc, 1 set or 2 set</p>		
<p>Min. material density sensed</p>	<p>Solid: ≥0.07g/cm³, Liquid: ≥0.7g/cm³</p>		
<p>Time delay</p>	<p>0.6 Second / Operate; 1~3 Seconds / Reset</p>		
<p>Vibrating frequency.</p>	<p>350~370Hz</p>		
<p>Selectable Fail-safe</p>	<p>Hi. / Lo.</p>		
<p>Selectable sensitivity</p>	<p>Hi. / Lo.</p>		

EX-PROOF TYPE

<p>Dimensions (Unit:mm)</p>		
<p>Model No.</p>	<p>SC1740 【Standard Type】</p>	<p>SC1741 【Tuning Fork Ultra Extension Type】</p>
<p>Level sensor housing</p>	<p>Aluminum / IP65</p>	
<p>Probe material</p>	<p>SUS 304 / 316 / 316L</p>	
<p>Mounting</p>	<p>1"PT</p>	<p>1"PT</p>
<p>Conduit</p>	<p>1/2"NPT×2</p>	
<p>Max. vertical load on rod.</p>	<p>177in.Lbs(20Nm)</p>	
<p>Process pressure.</p>	<p>-1~600PSI (40BAR)</p>	
<p>Power supply</p>	<p>20~250,50/60Hz Vac/Vdc</p>	
<p>Power consumption</p>	<p>10VA</p>	
<p>Ambient temp.</p>	<p>-20°C~70°C</p>	
<p>Process temp.</p>	<p>-40°C~125°C</p>	
<p>Signal output</p>	<p>Relay, SPDT, 3A / 250Vac / 28Vdc, 1 set or 2 set SSR(MOSFET) 400mA/60 Vac / Vdc, 1 set or 2 set</p>	
<p>Min. material density sensed</p>	<p>Solid: ≥0.07g/cm³, Liquid: ≥0.7g/cm³, viscosity : 1~10000 cst</p>	
<p>Time delay</p>	<p>0.6 Second / Operate; 1~3 Seconds / Reset</p>	
<p>Vibrating frequency.</p>	<p>350~370Hz</p>	
<p>Selectable Fail-safe</p>	<p>Hi. / Lo.</p>	
<p>Selectable sensitivity</p>	<p>Hi. / Lo.</p>	

SC35 TUNING FORK LEVEL SWITCH



NEPSI Ex tD A21 IP66/67 T80°C / T95°C / T130°C / T195°C / T290°C
 IECEx Ex ta IIIC T95°C / T130°C / T136°C Da
 Ex tb IIIC T80°C / T95°C / T130°C / T160°C / T240°C / T290°C Db

Dimensions (Unit:mm)			
Model No.	SC350 [Standard Type]	SC351 [Extension Type]	SC352 [Cable Type]
Level sensor housing	Built-in box, aluminum coating IP66/IP67		
Probe material	SUS 304 / 316 / 316L		
Power supply	19 ~253 Vdc / Vac, 50/60 Hz ; NPN / PNP(10~55Vdc)		
Probe construction	Max. 1.5 W		
Voltage endurance capability	3.7 kV		
Overvoltage protection	overvoltage category II		
Ambient temp.	-40~85 °C		-40~75 °C
Process temp.	-40~150 °C	-40~150 °C	-40~80 °C
Material density	$\geq 0.01 \text{ g/cm}^3$ or $\geq 0.05 \text{ g/cm}^3$		
Measuring frequency	140 Hz \pm 5 Hz		
Material dimension	Max.10 mm		
Conduit	1/2"PF / 1/2"NPT(Ex-proof type only supports 1/2"NPT)		
External diameter of conduit cable	$\phi 6 \sim \phi 10 \text{ mm}$		
Process pressure	Max.25 Bar		Max. 2 Bar
Output signal	2 sets of SPDT relay output / 2 sets of transistor output / 3 wires NPN/PNP transistor output		
Contact capacity	Relay: 6A / 250Vac , 6A / 28Vdc ; Transistor: 350mA , 60Vac / Vdc NPN / PNP / Transistor: 350mA , 55Vdc		

SC35 TUNING FORK LEVEL SWITCH



NEPSI Ex tD A21 IP66/67 T80°C / T95°C / T130°C / T195°C / T290°C
 IECEx Ex ta IIIC T95°C / T130°C / T136°C Da
 Ex tb IIIC T80°C / T95°C / T130°C / T160°C / T240°C / T290°C Db

Dimensions (Unit:mm)		
Model No.	SC350 [High-temp. Type]	SC351 [High-temp. Extension Type]
Level sensor housing	Built-in box, aluminum coating IP66/IP67	
Probe material	SUS 304 / 316 / 316L	
Power supply	19 ~253 Vdc / Vac, 50/60 Hz	
Probe construction	Max. 1.5 W	
Voltage endurance capability	3.7 kV	
Overvoltage protection	overvoltage category II	
Ambient temp.	-40~85 °C	
Process temp.	-40~280 °C	
Material density	$\geq 0.01 \text{ g/cm}^3$ or $\geq 0.05 \text{ g/cm}^3$	
Measuring frequency	140 Hz \pm 5 Hz	
Material dimension	Max.10 mm	
Conduit	1/2"PF / 1/2"NPT(Ex-proof type only supports 1/2"NPT)	
External diameter of conduit cable	$\phi 6 \sim \phi 10$ mm	
Process pressure	Max. 25 Bar	
Output signal	2 sets of SPDT relay output / 2 sets of transistor output	
Contact capacity	Relay: 6A / 250Vac , 6A / 28Vdc Transistor: 350mA , 60Vac / Vdc	

SC38 MULTI-FUNCTIONAL TUNING FORK LEVEL SWITCH



NEPSI Ex ia IIC T3-T6 Ga

Dimensions (Unit:mm)	<p>SC380 【Standard Type】</p>	<p>SC381 【Extension Type】</p>	<p>SC382 【Ultra Extension Type】</p>
-------------------------	---	--	--

Output type	8/16mA output type	3 Wires (NPN/PNP) output type	Dual-relay output type
Working voltage	11 ~36 Vdc	10 ~55 Vdc	19~253Vac / 2dc,50 / 260Hz
Power consumption	< 600mW	< 830mW	Max. 1.3W
Input protection	Reversed power supply protection function		NA
Overvoltage protection	overvoltage category III		
Measuring error	Max.±1mm		
Repeatability	0.5mm		
Hysteresis band	Approx.2mm		
Ambient temp.	-40~85 °C (Intrinsically safe type -40~70 °C)	-40~85 °C(Refernce operation manual)	
Process temp.	-40~150 °C		
Applicable density liquid	≥0.5 g/cm ³ or ≥0.7 g/cm ³		
Liquid viscosity	Max.10000mm ² / S(10000cst)		
Granule size contained in the liquid	Max.φ5 mm		
External diameter of conduit cable	φ6~φ10 mm		
Process pressure	Max.40 Bar		
Output signal	Intrinsically safe signal 8 / 216mA	Transistor output (NPN/PNP)	2 sets of SPDT relay output
Contact capacity	NA	350mA , 55Vdc	6A / 250Vac , 6A / 28Vdc
Protection level	IP66/67		
Probe material	SUS 304 / 2316 / 316L		
Intrinsically safe parameters	Ui(V)=36V , li=100mA, Pi=1W Ci(nF)=0 , Li(uH)=0※	NA	NA

※ Must be equipped with intrinsic safety barrier to form a standard intrinsically safe system (Ex ia), please refer to another DM/brochure for TXX safety barrier.

SC38 MULTI-FUNCTIONAL TUNING FORK LEVEL SWITCH



NEPSI Ex ia IIC T3~T6 Ga

Dimensions (Unit:mm)	<p>SC380 【High-temp. Type】</p>	<p>SC381 【High-temp. Extension Type】</p>	<p>SC382 【High-temp. Extension Type】</p>
-------------------------	---	---	---

Output type	8/16mA output type	3 Wires (NPN/PNP) output type	Dual-relay output type
Working voltage	11 ~36 Vdc	10 ~55 Vdc	19~253Vac/dc,50/60Hz
Power consumption	< 600mW	< 830mW	Max. 1.3W
Input protection	Reversed power supply protection function		NA
Overvoltage protection	overvoltage category III		
Measuring error	Max.±1mm		
Repeatability	0.5mm		
Hysteresis band	Approx.2mm		
Ambient temp.	-40~85 °C(Refernce operation manual)		
Process temp.	-40~150 °C		
Applicable density liquid	≥0.5 g/cm ³ or ≥0.7 g/cm ³		
Liquid viscosity	Max.10000mm ² / S(10000cst)		
Granule size contained in the liquid	Max.φ5 mm		
External diameter of conduit cable	φ6~φ10 mm		
Process pressure	Max.40 Bar		
Output signal	Intrinsically safe signal 8/16mA	Transistor output (NPN/PNP)	2 sets of SPDT relay output
Contact capacity	NA	350mA , 55Vdc	6A / 250Vac , 6A / 28Vdc
Protection level	IP66/67		
Probe material	SUS 304 / 316 / 316L		
Intrinsically safe parameters	Ui(V)=36V , li=100mA,Pi=1W Ci(nF)=0 , Li(uH)=0※	NA	NA

※ Must be equipped with intrinsic safety barrier to form a standard intrinsically safe system (Ex ia), please refer to another DM/brochure for TXX safety barrier.

WIRING INSTRUCTIONS (STANDARD TYPE)

SC14XX, SC174X

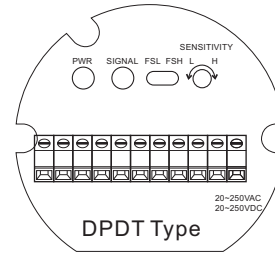
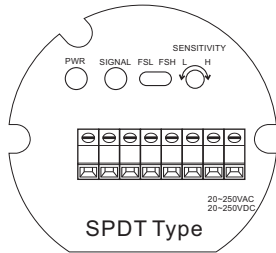

Relay output type(SPDT)

SSR(MOSFET) output type

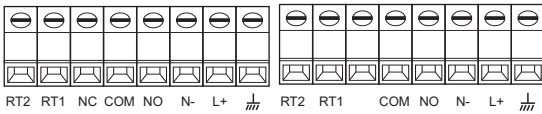

RT2 RT1 NC COM NO N- L+ \perp RT2 RT1 COM NO N- L+ \perp

Relay output type (DPDT)

SSR(MOSFET) output type

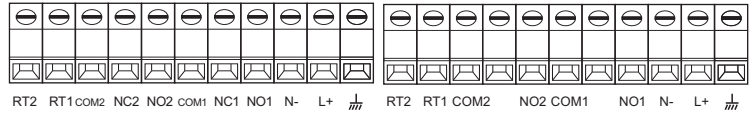

RT2 RT1 COM2 NC2 NO2 COM1 NC1 NO1 N- L+ \perp RT2 RT1 COM2 NO2 COM1 NO1 N- L+ \perp

FUNCTIONAL DESCRIPTION

Description of terminal functions

- L+, N-: Power Supply
- NC, COM, No: Relay Output
- RT1, RT2: Remote-Test
- \perp : Ground Connection
- COM1, NO1 : SSR(MOSFET) Output
- COM2, NO2 : The second set of SSR (MOSFET) output (Optional)

DESCRIPTION OF PANEL FUNCTIONS

- PWR: Power Supply (Green Light)
- SIGNAL: Output Indication (Red Light)
- FSH: Power On. The signal lamp is on and the relay is conductive. While the tuning fork switch senses the material, the signal lamp is off and relay is not conductive.
- FSL: Power On. The signal lamp is off and the relay is not conductive. While the tuning fork switch senses the material, the signal lamp is on and relay is conductive.
- SENSITIVITY L: Low Sensitivity
- SENSITIVITY H: High Sensitivity

FAIL-SAFE HIGH / LOW PROTECTION

FSH (Fail-Safe High) Protection:

Switch to FSH mode.

Normal Status: The signal lamp is on. It indicates that the tuning fork switch does not sense the material and the relay is conductive.

Failure: When the power shuts down, the signal lamp is off. It indicates that the tuning fork switch is voided and the relay is not conductive.

FSL (Fail-Safe Low) Protection:

Switch to FSL mode.

Normal Status: The signal lamp is on.

The tuning fork switch senses the material and the relay is conductive.

Failure: When the power shuts down, the signal lamp is off. The tuning fork switch is voided and the relay is not conductive.

SENSITIVITY ADJUSTMENT

The SENSITIVITY is located on the right side of the panel. Minor adjustment can be made by rotating the sensitivity up to 22 turns using a small screw driver. Rotating clockwise will increase sensitivity; rotating counter-clockwise will decrease sensitivity.

The sensitivity is originally set at max. value. The switching point is at 15mm from the tip of the tuning fork. The switching point position will be changed by the sensitivity value. If the sensitivity adjusts to lower value, the switching point position is moving backward; if the sensitivity adjusts to high value, the switching point position is moving forward. User may change the switching point position by adjusting the sensitivity. The changing range of switching point is about 60mm. For example, if the switching point needs to be moved backward by 30mm, the user needs to adjust SENSITIVITY counter-clockwise by 10 turns. In general cases, there is no need for sensitivity adjustment.

	FSL		FSH	
Level				
Contact form	NO COM NC	NO COM NC	NO COM NC	NO COM NC
Indication	○	☀	☀	○
Status	Fail	Normal	Normal	Fail

WIRING INSTRUCTIONS (LITE-TYPE/MINI-TYPE)

SC240X/SC280(TWO WIRES) WIRING

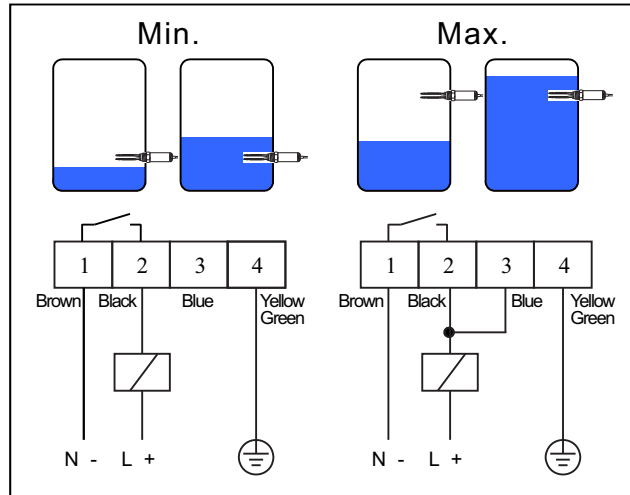
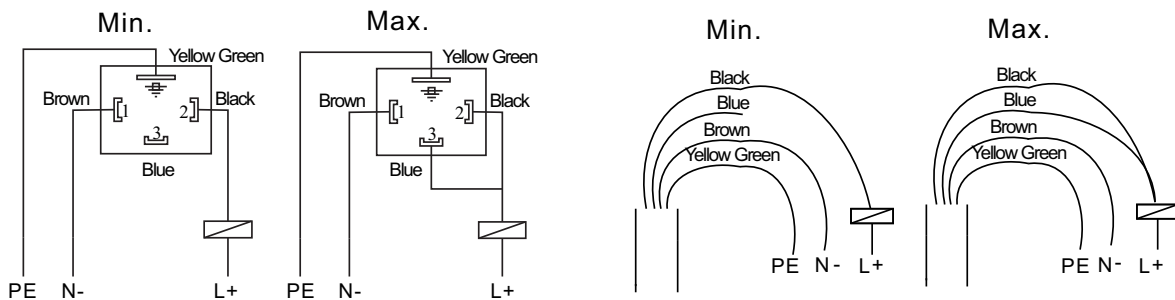

Figure 1 Two Wires Wiring



DIN Wiring Diagram

M12x4Pin Cable Wiring Diagram

Wiring

Power can be AC/DC switching. Two wires are connected with terminals (L+/N-) as in Figure 1.

■ Low (Min.) mode:

Pin 1 (Brown) is connected to N-. Pin 2 (Black) is connected to L+ with relay. Pin 4 (Yellow Green) connects to tank ground.

■ High (Max.) mode:

Pin 1 (Brown) is connected to N-. Pin 3 is connected to pin 2 (Black) to L+ with Relay. Pin 4 (Yellow Green) connects to tank ground.

WIRING INSTRUCTIONS (LITE-TYPE/MINI-TYPE)

SC24P/N,SC28P/N (THREE WIRES) WIRING

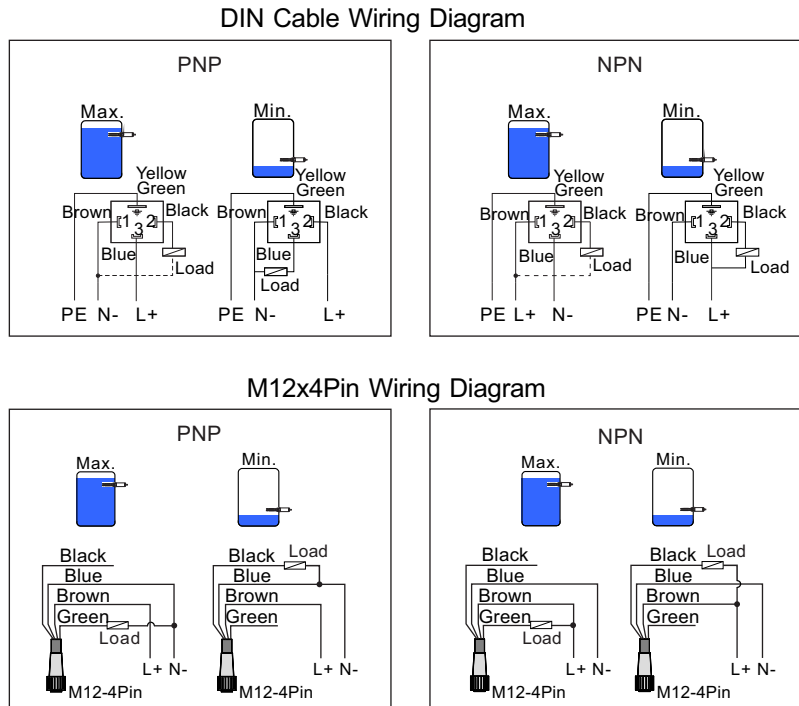

Figure 2 PNP / NPN Output Wiring Diagram

Wiring

Power supply is for DC only. Output is PNP / NPN and high / low level alarm. Please see Figure 2.

► DIN & Cable Wiring

PNP Output

- High (Max.) Mode: Pin 1(Brown) connects to N-. Pin 3 (Blue) connects to L+. To output, it is pin 2. (Black) connects to N- with relay. Pin 4 (Yellow Green) connects to tank ground.
- Low (Min.) Mode: Pin 1 (Brown) connects to N-. Pin 2 (Black) connects to L+. To output, Pin 3 (Blue) connects to N- with relay. Pin 4 (Yellow Green) should contact to tank ground.

NPN Output

- High (Max.) Mode: Pin 1 (Brown) connects to L+. Pin 3 (Blue) connects to N-. To output, Pin 2 (Black) connects to L+ with relay. Pin 4(Yellow Green) should contact to tank ground.
- Low(Min.)Mode: Pin1 (Brown) connects to N-. Pin 3 (Blue) connects to L+. To output Pin 2 (Black) connects to L+ with relay. Pin 4 (Yellow Green) should contact To tank ground.

► M12 x 4Pin Wiring:

PNP Output

- High(Max.) Mode: No. 1 pin(Brown) is connected to L+. No.3 pin(Blue) is connected to N-. Output is connected to No. 2 pin(Green), then connected to N-.
- Low(Min.) Mode: number 1 pin(Brown) is connected to L+. No.3 pin(Blue) is connected to N-. Output is connected to No. 4 pin(Black), then connected to N-.

NPN Output

- High(Max.) Mode: No. 1 pin(Brown) is connected to L+. No.3 pin(Blue) is connected to N-. Output is connected to No. 2 pin(Green), then connected to L+.
- Low(Min.) Mode: No. 1 pin(Brown) is connected to L+. No.3 pin(Blue) is connected to N-. Output is connected to No. 4 pin(Black), then connected to L+.

WIRING INSTRUCTIONS (SC35)

WIRING CONFIGURATION DIAGRAM AND INTRODUCTION OF FEATURES

Dual-relay output

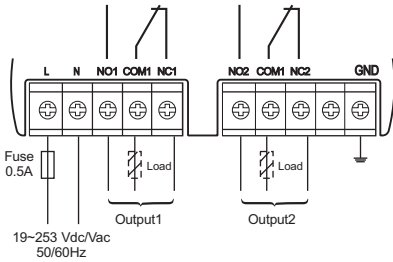

Load: External load
 $U \sim \text{max. } 250\text{Vac}@I_L \sim \text{max. } 6\text{A}$
 $U = \text{max. } 28\text{Vdc}@I_L = \text{max. } 6\text{A}$

Failure mode	Material level	Output signal			LED indicators		
		output1	output2		Power Green	Status Yellow	Alarm Red
			S.S. OFF	S.S. ON			
MAX						O.S. F.S.	
						O.S. F.S.	
MIN						O.S. F.S.	
						O.S. F.S.	
Viscous material		Maintain the previous state				O.S. F.S.	
Wear of tuning fork							

Dual-transistor output

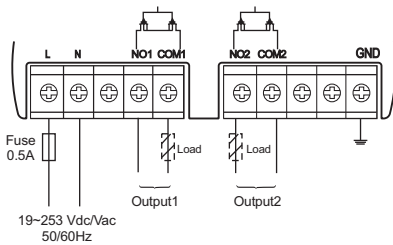

Load: External load
 $U \sim \text{max. } 60\text{Vac}@I_L \sim \text{max. } 350\text{mA}$
 $U = \text{max. } 60\text{Vdc}@I_L = \text{max. } 350\text{mA}$
 ※ External load R must be connected

Failure mode	Material level	Output signal			LED indicators		
		output1	output2		Power Green	Status Yellow	Alarm Red
			S.S. OFF	S.S. ON			
MAX						O.S. F.S.	
						O.S. F.S.	
MIN						O.S. F.S.	
						O.S. F.S.	
Viscous material		Maintain the previous state				O.S. F.S.	
Wear of tuning fork							
Output1>350mA			Maintain the previous state				
Output2>350mA		Maintain the previous state					
Output1 & Output2>350mA							

※ When output is off, there will be no error current status

: ON : Flash : OFF

: Relay ON : Relay OFF I_L : Load current

WIRING INSTRUCTIONS (SC38)

WIRING CONFIGURATION DIAGRAM AND INTRODUCTION OF FEATURES

8/16mA output

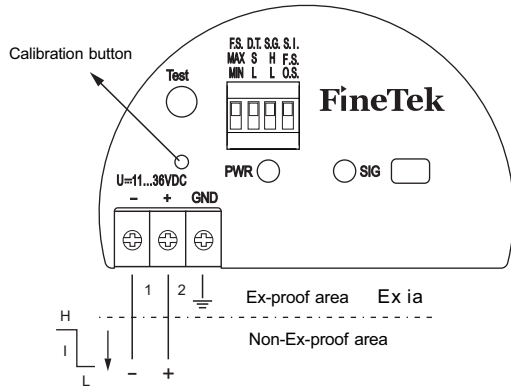

PNP/NPN Output

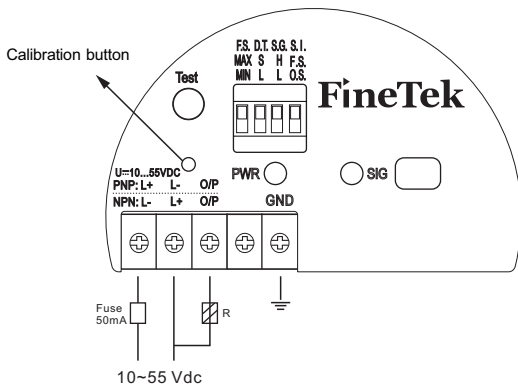

Dual Relay output

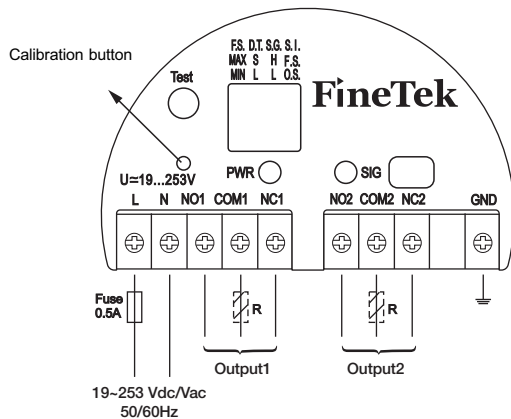

Failure mode	Material level	Output signal	LED indicators
MAX		+ 2 → ~16mA → 1	O.S. F.S.
		+ 2 → ~8mA → 1	O.S. F.S.
MIN		+ 2 → ~16mA → 1	O.S. F.S.
		+ 2 → ~8mA → 1	O.S. F.S.
Instrument failure		+ 2 → <3.6mA → 1	

~16mA=16mA ± 5%

~8mA=8mA ± 5%

: ON : Flash : OFF

Failure mode	Material level	Output signal	LED indicators
MAX		→ I _L →	O.S. F.S.
		→ <100μA →	O.S. F.S.
MIN		→ I _L →	O.S. F.S.
		→ <100μA →	O.S. F.S.
Instrument failure		→ <100μA →	
Over Load(I _L >350mA)		→ <100μA →	

I_L : Load current

R : External load

U = max. 55Vdc@I_L = max. 350mA

: ON : Flash : OFF

Failure mode	Material level	Output signal	LED indicators	
			PWR	SIG
MAX			O.S. F.S.	
			O.S. F.S.	
MIN			O.S. F.S.	
			O.S. F.S.	
Instrument failure				

R: External load

U ~ max. 250Vac@I_L ~ max. 6A

U = max. 28Vdc@I_L = max. 6A

: ON : Flash : OFF

TUNING AND INDICATION DETAILS

FORK TRIGGER POINT

SC1X/SC24 fork trigger point is shown as below figure.

The testing medium is water(S.G.=1 g/cm³), and its trigger point is about 23mm from the fork tip. If testing medium with S.G (specific gravity) lower than 1g/cm³ (water), the trigger point would increase. Similarly, the trigger point will downward while the S.G is large than water.

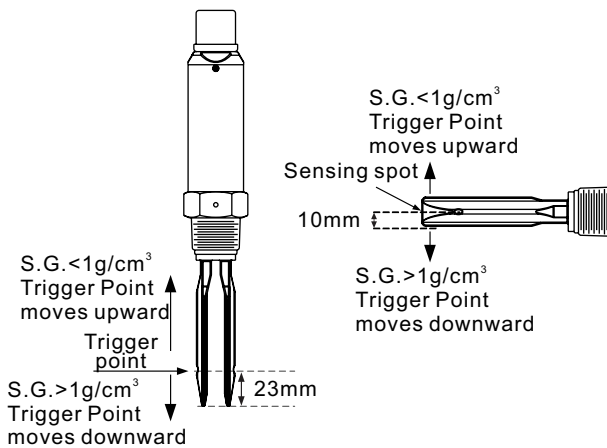

MAGNETIC TEST

After the switch is installed and powered, magnetic test function can be performed accordingly. The testing point is marked on the housing label. User holds the magnet and moves it close to testing point, the output status will switch from NO. to NC. or NC to NO. and red LED would switch ON or OFF while fork continues to vibrate. When magnet is pulled away from the testing point, the output status and red LED would return as default while fork continues to vibrate. The purpose of testing is to confirm the wiring and functioning are correct.

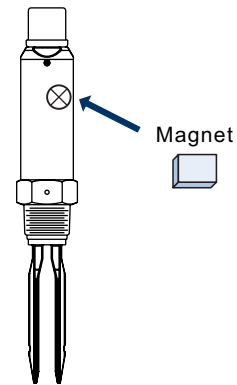

TUNING AND INDICATION DETAILS(LITE-TYPE/MINI-TYPE)

Output Status For Relay

- Low (Min.) Mode: Tuning fork switch will be active after 3 seconds while power on. Relay is on NO status and red LED indication is off. When tuning fork is covered by testing medium, the vibration will stop and relay becomes NC status. Red LED indication then is on.
- High(Max.) Mode: Tuning fork switch will be active after 3 seconds while the power on. Relay is on NC status and red LED indication is on. When tuning fork covered by testing medium, the vibration stops and relay becomes NO status. Red LED indication is on.
- Flashing red indicates abnormal: Possible causes overloads or short-circuit load back, equipment malfunction or wear tuning fork probe.

	Min. Mode		Max.Mode		
Level					Instrument failure
Contactless electronic switch	 Switch open	 Switch closed	 Switch closed	 Switch open	 Switch open
Red LED					

It represents Blinking

Output Status For PNP / NPN Transistor

DIN & Cable type

- Low(Min.) Mode: Tuning fork switch will be active after 3 seconds while power on. Output transistor is on NO status and red LED indication is on. When tuning fork covered by testing medium,vibration will stop and output transistor becomes NC status. Red LED indication is off.
- High(Max.) Mode: Tuning fork switch will be active after 3 seconds while power on. Output transistor is on NC status and red LED indication is on. When tuning fork covered by testing medium,vibration will stop and output transistor becomes NO status. Red LED indication is off.
- Flashing red indicates abnormal: Possible causes overloads or short-circuit load back, equipment malfunction or wear tuning fork probe.

M12 x 4Pin type

-
-
-

	Min. Mode		Max.Mode		
Level					Instrument failure
PNP/NPN Output	 Switch open	 Switch closed	 Switch closed	 Switch open	 Switch open
Red LED (DIN& Cable)					
Red LED (M12x 4Pin)					

It represents Blinking

DESCRIPTION OF FEATURES (SC35)

PANEL INTRODUCTION

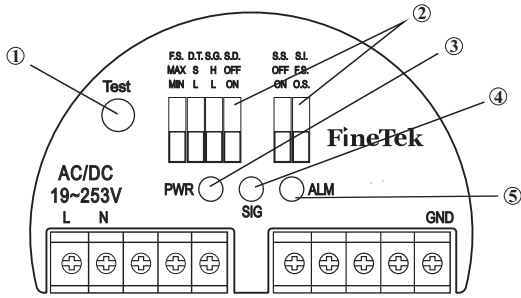

- ①: Test button
- ②: Function adjustment button
- ③: Power indicator
- ④: Status indicator
- ⑤: Alarm indicator

Abbreviation	Function	Option description	Remarks
Test	Test button	Reverse the signal output	It is for the test after the installation is completed.
F.S.	Fail-Safe	MAX: High MIN: Low	It is for the high and low Fail-Safe mode.
D.T.	Delay Time	S: General setting L: Delay for 5 seconds	Covered by material: 0.5s Not covered by material: 150°C: ≤1.5s 230□/280°C: ≤2s Switch to L to set it at 5 seconds for either covered or not covered by material.
S.G.	Specific Gravity	H: ≥0.05 g/cm ³ L: ≥0.01 g/cm ³	The switch to set the material density.
S.D.	Self Diagnosis	OFF: Disabled ON: Enabled	Detect the wear of the tuning fork or the viscous material and control the ON/OFF of the alarm indicator
S.S.	Super Switch	OFF: Disabled ON: Enabled	Switch the second set of output switch to the alarm indicator of the wear of the tuning fork or the viscous material for output
S.I.	Signal Indication	F.S.: Fail-Safe mode O.S.: Output mode	Turn ON/OFF the yellow indicator based on the output status or the fail-safe status.

SEDIMENT DETECTION

- It is only used to detect the sediment under the water, but can't be used for the level detection of the liquid or the doped liquid.
- S.G. (Specific Gravity) shall be adjusted to H position.
- S.D. (Self Diagnosis) shall be switched to OFF position.
- SC352 cable type is inapplicable to this working environment

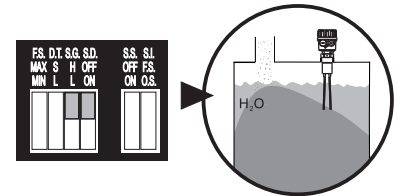

ENVIRONMENT/PROCESS TEMPERATURE LIMITATION

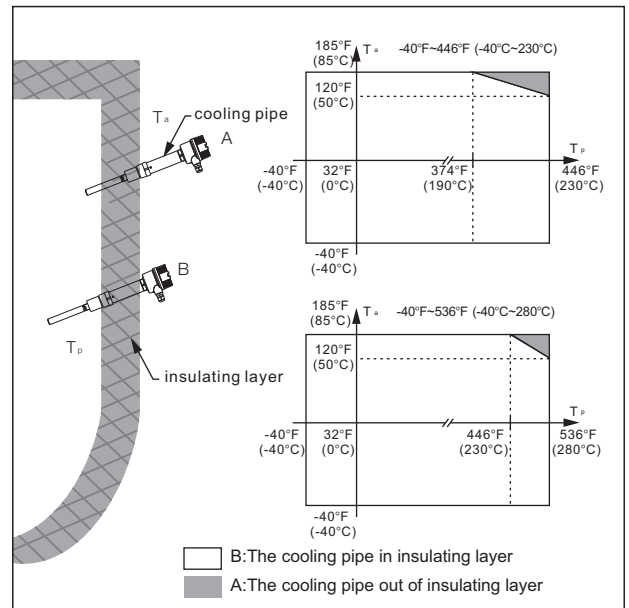
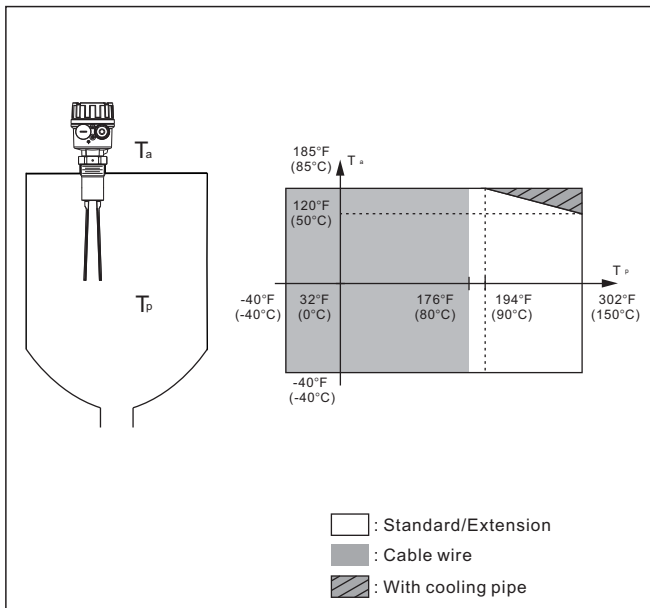

- ※ ETFE coating: T_p max. = 150°C
- ※ PTFE coating: T_p max. = 230°C

DESCRIPTION OF FEATURES (SC38)

PANEL INTRODUCTION

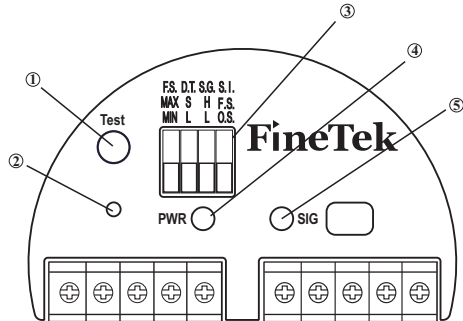

- ①: Test button
- ②: Operation point calibration button
- ③: Function adjustment button
- ④: Power indicator
- ⑤: Status indicator

Abbreviation	Function	Option Description	Remarks
Test	Test button	Reverse the signal output	It is for the test after the installation is completed.
F.S.	Fail-Safe	MAX: High MIN: Low	It is for the high and low Fail-Safe mode.
D.T.	Delay Time	S: General setting L: Delay for 5 seconds	Covered by material: Approx. 0.5s Not covered by material: Approx. 1s Switch to L to set it at 5 seconds for either covered or not covered by material.
S.G.	Specific Gravity	H: $\geq 0.7 \text{ g/cm}^3$ L: $\geq 0.5 \text{ g/cm}^3$	The switch to set the material density.
S.I.	Signal Indication	F.S.: Fail-Safe mode O.S.: Output mode	Turn ON/OFF the yellow indicator based on the output status or the fail-safe status.

DESCRIPTION OF THE TEST BUTTON

This button is mainly provided for the user to check whether the output operation works normally after the installation is completed. When the button is pressed, the output current (8mA \leftrightarrow 16mA) and indicator (ON \leftrightarrow OFF) will be reversed. Once the button is released, it will recover the original status.

FUNCTION OF CUSTOMIZED OPERATION POINT POSITION

SC38 provides the function of customizing the operation point position according to what is required by the user.

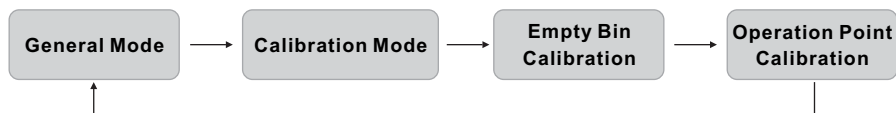

Settings

1. Keep pressing "Calibration Button" for 3 seconds. When the red and green LED indicators flash every 0.5 second, it enters the calibration mode. Press the calibration button again to enter the Empty Bin Calibration mode.

[Empty Bin Calibration]

2. Calibration status: The red LED indicator flashes every 0.5 second, and the output current switches to operate every 0.5 second (8 \leftrightarrow 16mA).

3. This mode is to calibrate the vibration frequency of the tuning fork in the air. Press "Calibration Button" when the tuning fork doesn't touch any material. The unit will record the vibration frequency in the air, and enter the operation point calibration mode.

[Operation Point Calibration]

1. Calibration status: The red LED indicator flashes every 0.25 second, and the output current switches to operate every 0.25 second (8 \leftrightarrow 16mA).

2. Cover the material to the desired operating point position under this mode, and then press "Calibration Button". It will be adjusted to the corresponding operating point position according to the H/L setting of the S.G.

DESCRIPTION OF FEATURES (SC38)

FORK TRIGGER POINT

The position of the SC38 fork trigger point depends on the mounting position as shown in the figure below: (When the testing medium is water, S.G.=1 g/cm³, the distance of the trigger point is 13mm). If the testing medium has an S.G lower than 1g/cm³, the trigger point would rise. Similarly, the trigger point will move downward while the S.G is greater than water. The moving distance is subject to the S.G.

※Operating point position: ◀

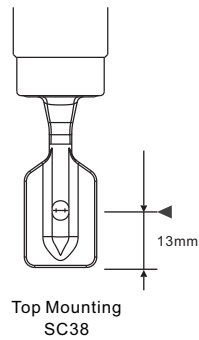

ENVIRONMENT AND PROCESS TEMPERATURE LIMITATION

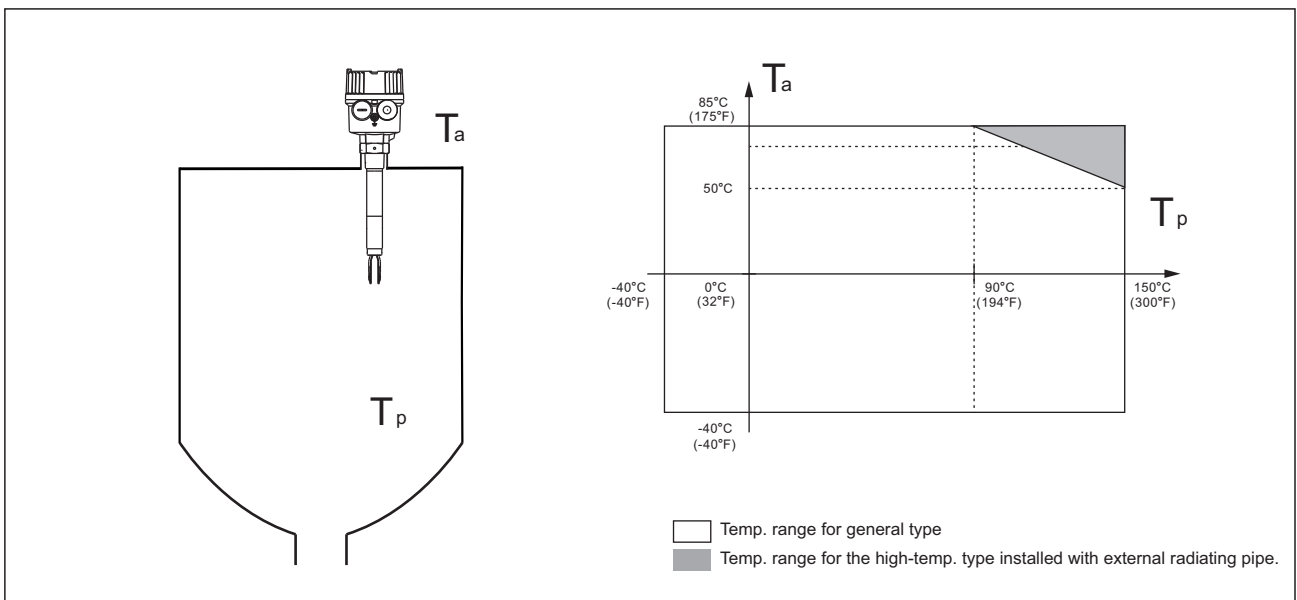

MODEL NUMBER / ORDER CODE COMPARISON TABLE

Model Number	Order Code
SC1400	SCX10000-AAB
SC1410	SCX10000-CAB
SC1420	SCX10000-BAB
SC1740	SCX1001C-AAB
SC1741	SCX1001C-CAB

SC2400	SCX2□□00-□BA
SC240□□T	SCX20200-□BA
SC24P□	SCX2□□00-□BP
SC24N□	SCX2□□00-□BN
SC2800	SCX2□□00-□AA
SC280□□T	SCX20200-□AA
SC28P□	SCX2□□00-□AP
SC28N□	SCX2□□00-□AN

SC350	SCX3□□□□-EC(HC,JC)
SC351	SCX3□□□□-FC(IC,KC)
SC352	SCX3□□□□-DC
SC380	SCX3□□□□-AA(EA)
SC381	SCX3□□□□-BA(FA)
SC382	SCX3□□□□-CA(GA)

ORDER INFORMATION

STANDARD-TYPE

SCX1 ⁰⁵ ⁰⁶ ⁰⁷ ⁰⁸ ⁰⁹ - ¹² ¹³ ¹⁴ ¹⁵ ¹⁶ ¹⁷ ¹⁸ ¹⁹ ²⁰ ²¹ ²² ²³ ²⁴ ²⁵ ²⁶ A B

⁰⁵ ⁰⁶ **Model**

- 00: Standard
- 03: Sanitary

⁰⁷ ⁰⁸ **Certification**

- 00: None
- 1C: ATEX-Ex d
- 2C: IECEx-Ex d
- 7C: NEPSI-Ex d
- 5C: TS-Ex d

⁰⁹ **Construction**

- A: Standard
- B: Extended type
- C: Lengthened type
- D: Cable type
- E: Anti-Corrosion probe type
- F: Anti-Corrosion extended probe type
- G: Sanitary joint type

¹² **Power supply**

- C: 20~250Vac/Vdc, 50/60Hz ; Relay O/P - Euro terminal
- D: 20~250Vac/Vdc, 50/60Hz ; SSR(MOSFET) - Euro terminal
- E: 20~250Vac/Vdc, 50/60Hz ; Relay O/P*2 - Euro terminal
- F: 20~250Vac/Vdc, 50/60Hz ; SSR(MOSFET)*2 - Euro terminal

(Next page)

Connection

¹³ ¹⁴

- Flange
- AK: JIS-FF
- AN: ANSI-RF
- AS: DIN-FF
- AI: 3A

¹⁵ ¹⁶

- A8: 1"
- A9: 1-1/4"
- B1: 1-1/2"
- B2: 2"
- B4: 2-1/2"
- B5: 3"
- B7: 4"
- D8: DN25
- E1: DN40

¹⁷ ¹⁸

- 01: PT male
- 03: PF male
- 07: NPT male
- 40: 5 kg/cm²
- 42: 10 kg/cm²
- 48: 150 Lbs
- 49: 300 Lbs
- 57: PN10
- 58: PN16

ORDER INFORMATION

SCX1 ⁰⁵ ⁰⁶ ⁰⁷ ⁰⁸ ⁰⁹ - ¹² ¹³ ¹⁴ ¹⁵ ¹⁶ ¹⁷ ¹⁸ ¹⁹ ²⁰ ²¹ ²² ²³ ²⁴ ²⁵ ²⁶ A B

¹⁹ ²⁰ **Probe material**

- MA: SUS304
- MB: SUS316
- MC: SUS316L

²¹ ²² **Coating material**

- 00: None
- 14: PFA
- 34: ECTFE
- ※ Coating length max. 400mm

²³ ²⁴ ²⁵ ²⁶ **Probe length**

Code	Probe Length
0001~9999	0001~9999mm

ORDER INFORMATION

LITE-TYPE/MINI-TYPE

SCX2 ⑤⑥ 0 0 - ⑨ ⑩ ⑪ ⑫ ⑬ ⑭ ⑮ ⑯ ⑰ ⑱ ⑲ ⑳ ㉑ ㉒ ㉓ ㉔

⑤⑥ **Model**
 00: Standard
 02: Hi-temperature
 03: Sanitary

⑨ **Construction**
 A: Standard
 B: Extended type

⑩ **Fork length**
 A: 40mm
 B: 100mm

⑪ **Power supply**
 A: 20~250Vac/Vdc, 50/60Hz; 2 wire Contactless electronic switch
 P: 12~55Vdc ; 3 Wire PNP output.
 N: 12~55Vdc ; 3 Wire NPN output.

Connection

⑫⑬ Flange AK: JIS-FF AN: ANSI-RF AS: DIN-FF AI: 3A Thread AA: JIS AC: ANSI	⑭⑮ A7: 3/4" A8: 1" A9: 1-1/4" B1: 1-1/2" B2: 2" B4: 2-1/2" B5: 3" B7: 4" D8: DN25 E1: DN40	⑯⑰ 01: PT male 03: PF male 07: NPT male 40: 5 kg/cm ² 42: 10 kg/cm ² 48: 150 Lbs 49: 300 Lbs 57: PN10 58: PN16
--	--	---

⑱⑲ **Probe material**
 MA: SUS304
 MB: SUS316
 MC: SUS316L

⑳ **Connection**
 A: M12x1(180°) C: Cable
 B: M12x1(90°) D: DIN 43650

㉑ ㉒ ㉓ ㉔ **Probe length**

Code	Probe Length
0076~0250	0076~0250mm

ORDER INFORMATION

MULTI-FUNCTIONAL-TYPE SCX3 ⁰⁵ ⁰⁶ ⁰⁷ ⁰⁸ - ⁰⁹ ¹⁰ ¹¹ ¹² ¹³ ¹⁴ ¹⁵ ¹⁶ ¹⁷ ¹⁸ ¹⁹ ²⁰ ²¹ ²² ²³ ²⁴ ²⁵ ²⁶ ²⁷ ²⁸

05 06 Model _____

- 00: Standard
(Construction: A, B, C, D)
- 02: Hi-temperature
(Construction: E, F, G)
- 09: High temperature type 2
(Construction: J, K)

07 08 Certification _____

- 01: None; 1/2" PF
- 02: None; 1/2" NPT
- 03: None; M20x1.5
- 2D : IECEx-Ex t : 1/2"NPT
- 5D: TS-Ex t; 1/2" NPT
- 7B: NEPSI-Ex ia; 1/2" NPT
- 7D: NEPSI-Ex d; 1/2" NPT

09 Construction _____

- A: Standard (150°C @ 50°C)
- B: Extended type (150°C @ 50°C)
- C: Lengthened type (150°C @ 50°C)
- D: Cable type (80°C)
- E: High temperature general type
(150°C @ 85°C)
- F: High temperature extension type
(150°C @ 85°C)
- G: High temperature lengthening type
(150°C @ 85°C)
- J: High temperature type 2 (280°C)
- K: High temperature extended type 2 (280°C)

10 Fork length _____

- A: 40mm(SC38)
- C: 155mm(SC35)

11 Housing _____

- F: Aluminum
- R: stainless steel (No explosion protection)

12 Housing cover _____

- A: No Lens
- B: Lens(only stainless steel)

(Next page)

ORDER INFORMATION

SCX3 ⑤⑥⑦⑧⑨⑩⑪⑫⑬⑭⑮⑯⑰⑱⑲⑳㉑㉒㉓㉔㉕㉖㉗㉘

⑬ Power supply

- A: 19~253Vac/Vdc, 50/60Hz; Two Relay output
- B: 19~253Vac/Vdc, 50/60Hz; Two Transistor output
- C: 10~55Vdc; 3 wire PNP/NPN Output
- D: 11~36Vdc; 8/16mA Output

Connection

- | | | |
|---|---|--|
| <p>⑭ ⑮
Flange
AK: JIS-FF
AN: ANSI-RF
AS: DIN-FF
AI: 3A</p> <p>Thread
AA: JIS
AC: ANSI</p> | <p>⑯ ⑰
A7: 3/4"
A8: 1"
A9: 1- 1/4"
B1: 1-1/2"
B2: 2"
B4: 2-1/2"
B5: 3"
B7: 4"
D8: DN25
E1: DN40</p> | <p>⑱ ⑲
01: PT male
03: PF male
07: NPT male
40: 5 kg/cm²
42: 10 kg/cm²
48: 150 Lbs
49: 300 Lbs
57: PN10
58: PN16</p> |
|---|---|--|

⑳ ㉑ Probe material

- MA: SUS304
- MB: SUS316
- MC: SUS316L

㉒ ㉓ Coating material

- 00: None
 - 14: PFA
 - 21: PTFE
 - 34: ECTFE
 - 36: ETFE
- ※ Coating length max. 400mm

㉔ Surface roughness

- A: Ra ≤ 3.2um
- B: Ra ≤ 1.5um
- C: Ra ≤ 0.8um
- D: Ra ≤ 0.3um

㉕ ㉖ ㉗ ㉘ Probe length

Code	Probe Length
0075	75mm
0225~4000	225~4000mm
0750~A200	750~20000mm
0120~3000	120~3000mm

Global Network



■ Head Quarter

● Taiwan

FineTek Co., Ltd. - Taipei Head Quarter 
 No.16, Tzuchiang St., Tucheng Industrial Park
 New Taipei City 236, Taiwan
 TEL: 886-2-2269-6789
 FAX: 886-2-2268-6682
 EMAIL: info@fine-tek.com

■ North America

● California, U.S.

Aplus Finetek Sensor Inc. - US Office
 355 S. Lemon Ave, Suite D
 Walnut, CA 91789
 TEL: 1 909 598 2488
 FAX: 1 909 598 3188
 EMAIL: info@aplusfine.com

■ Europe

● Germany

FineTek GmbH - Germany Office
 Bei den Kämpen 26
 21220 Seevetal-Ramelsloh, Germany
 TEL: +49-(0)4185-8083-12
 FAX: +49-(0)4185-8083-80
 EMAIL: info@fine-tek.de

■ Asia

● China

Fine automation Co., Ltd. - Shanghai Factory 
 No.451 DuHui Rd, MinHang District, Shanghai,
 China 201109
 TEL: 86-21-6490-7260
 EMAIL: info.sh@fine-tek.com

● Singapore

FineTek Pte Ltd. - Singapore Office
 37 Kaki Bukit Place, Level 4 Singapore 416215
 TEL: 65-6452-6340
 EMAIL: info.sg@fine-tek.com

● Indonesia

PT. FineTek Automation Indonesia - Indonesia Office 
 PERGUDANGAN TUNAS BITUNG
 Jl. Raya Serang KM. 13,8, Blok C3 No. 12&15, Bitung Cikupa,
 Tangerang 15710
 TEL: 62 (021)-2958-1688
 EMAIL: info.id@fine-tek.com

● Mütec Instruments GmbH - Germany Office

Bei den Kämpen 26
 21220 Seevetal-Ramelsloh, Germany
 TEL: +49-(0)4185-8083-0
 FAX: +49-(0)4185-8083-80
 EMAIL: muetec@muetec.de



Distributor: